

Luminária para Zona 2

**MODELO AIWNR** (sem alojamento)

**ATMOSFERAS EXPLOSIVAS**  
**ZONAS 2** Grupos IIA, IIB e IIC  
**GRAU DE PROTEÇÃO:** IP66  
**CERTIFICADO DE CONFORMIDADE**  
**2004EC02CO064**

**DADOS CONSTRUTIVOS**

Fabricada em liga de alumínio fundido copper free, resistente à corrosão, globo de vidro borossilicato, resistente a choques térmicos e impactos, soquete de porcelana antivibratório. Guarnições em silicone.

Parafusos, arruelas e chassi em aço inox.

**ACABAMENTO**

Pintura a pó em poliéster cor cinza munsell N6.5.

**TRATAMENTO ANTICORROSIVO**

A pedido este produto pode ser fornecido com o tratamento anticorrosivo BlinCoat.

Veja detalhes na página 1.2

**ATMOSFERAS EXPLOSIVAS**

Este produto foi projetado e ensaiado de acordo com as normas vigentes de equipamentos para instalação em atmosferas explosivas.

Tipo de proteção: Ex-nR

**APLICAÇÃO**

Iluminação de áreas onde haja risco de explosão: indústrias petroquímicas, químicas, de tintas e vernizes, alimentícias, farmacêuticas, depósitos de produtos inflamáveis, cabines de pinturas, entre outros.



01- Conjunto ótico  
 02- Lâmpada  
 03- Conjunto soquete  
 04- Corpo

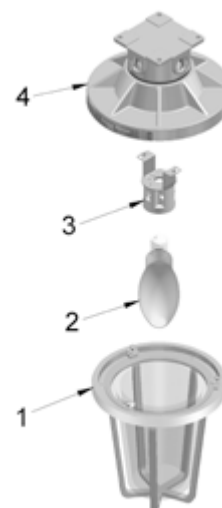

1

2

3

4

5

6

7

Produto	Modelo	Lâmpada*	Potência	Soquete	Class. Temp.	Dimensões (mm)		ØJ**
						A	B	
	AIWNR/1-INC100P	Incandescente	100 W	E27	T4	222	300	3/4"
	AIWNR/1-INC150P	Incandescente	150 W	E27	T3	222	300	3/4"
	AIWNR/1-INC200P	Incandescente	200 W	E27	T3	222	300	3/4"
	AIWNR/1-MST160P	Mista	160 W	E27	T3	222	300	3/4"
	AIWNR/1-PL20P	Flúor. Compacta	20 W	E27	T6	222	300	3/4"
	AIWNR/1-PL23P	Flúor. Compacta	23 W	E27	T6	222	300	3/4"
	AIWNR/1-PL25P	Flúor. Compacta	25 W	E27	T6	222	300	3/4"
	AIWNR/2-MST250P	Mista	250 W	E27/E40	T3	280	365	3/4"
AIWNR/2-INC300P	Incandescente	300 W	E27	T3	280	365	3/4"	
	AIWNR/1-INC100X	Incandescente	100 W	E27	T4	222	316	3/4"
	AIWNR/1-INC150X	Incandescente	150 W	E27	T3	222	316	3/4"
	AIWNR/1-INC200X	Incandescente	200 W	E27	T3	222	316	3/4"
	AIWNR/1-MST160X	Mista	160 W	E27	T3	222	316	3/4"
	AIWNR/1-PL20X	Flúor. Compacta	20 W	E27	T6	222	316	3/4"
	AIWNR/1-PL23X	Flúor. Compacta	23 W	E27	T6	222	316	3/4"
	AIWNR/1-PL25X	Flúor. Compacta	25 W	E27	T6	222	316	3/4"
	AIWNR/2-MST250X	Mista	250 W	E27/E40	T3	280	390	3/4"
AIWNR/2-INC300X	Incandescente	300 W	E27	T3	280	390	3/4"	
	AIWNR/1-INC100A30	Incandescente	100 W	E27	T4	450	330	3/4"
	AIWNR/1-INC150A30	Incandescente	150 W	E27	T3	450	330	3/4"
	AIWNR/1-INC200A30	Incandescente	200 W	E27	T3	450	330	3/4"
	AIWNR/1-MST160A30	Mista	160 W	E27	T3	450	330	3/4"
	AIWNR/1-PL20A30	Flúor. Compacta	20 W	E27	T6	450	330	3/4"
	AIWNR/1-PL23A30	Flúor. Compacta	23 W	E27	T6	450	330	3/4"
	AIWNR/1-PL25A30	Flúor. Compacta	25 W	E27	T6	450	330	3/4"
	AIWNR/2-MST250A30	Mista	250 W	E27/E40	T3	565	420	3/4"
AIWNR/2-INC300A30	Incandescente	300 W	E27	T3	565	420	3/4"	
	AIWNR/1-INC100A90	Incandescente	100 W	E27	T4	372	357	3/4"
	AIWNR/1-INC150A90	Incandescente	150 W	E27	T3	372	357	3/4"
	AIWNR/1-INC200A90	Incandescente	200 W	E27	T3	372	357	3/4"
	AIWNR/1-MST160A90	Mista	160 W	E27	T3	372	357	3/4"
	AIWNR/1-PL20A90	Flúor. Compacta	20 W	E27	T6	372	357	3/4"
	AIWNR/1-PL23A90	Flúor. Compacta	23 W	E27	T6	372	357	3/4"
	AIWNR/1-PL25A90	Flúor. Compacta	25 W	E27	T6	372	357	3/4"
	AIWNR/2-MST250A90	Mista	250 W	E27/E40	T3	403	430	3/4"
AIWNR/2-INC300A90	Incandescente	300 W	E27	T3	403	430	3/4"	
	AIWNR/1-INC100P25	Incandescente	100 W	E27	T4	383	296	1 1/2"
	AIWNR/1-INC150P25	Incandescente	150 W	E27	T3	383	296	1 1/2"
	AIWNR/1-INC200P25	Incandescente	200 W	E27	T3	383	296	1 1/2"
	AIWNR/1-MST160P25	Mista	160 W	E27	T3	383	296	1 1/2"
	AIWNR/1-PL20P25	Flúor. Compacta	20 W	E27	T6	383	296	1 1/2"
	AIWNR/1-PL23P25	Flúor. Compacta	23 W	E27	T6	383	296	1 1/2"
	AIWNR/1-PL25P25	Flúor. Compacta	25 W	E27	T6	383	296	1 1/2"
	AIWNR/2-MST250P25	Mista	250 W	E27/E40	T3	490	375	1 1/2"
AIWNR/2-INC300P25	Incandescente	300 W	E27	T3	490	375	1 1/2"	

Produto	Modelo	Lâmpada*	Potência	Soquete	Class. Temp.	Dimensões (mm)		ØJ**
						A	B	
	AIWNR/1-INC100P90	Incandescente	100 W	E27	T4	358	294	1 ½"
	AIWNR/1-INC150P90	Incandescente	150 W	E27	T3	358	294	1 ½"
	AIWNR/1-INC200P90	Incandescente	200 W	E27	T3	358	294	1 ½"
	AIWNR/1-MST160P90	Mista	160 W	E27	T3	358	294	1 ½"
	AIWNR/1-PL20P90	Flúor. Compacta	20 W	E27	T6	358	294	1 ½"
	AIWNR/1-PL23P90	Flúor. Compacta	23 W	E27	T6	358	294	1 ½"
	AIWNR/1-PL25P90	Flúor. Compacta	25 W	E27	T6	358	294	1 ½"
	AIWNR/2-MST250P90	Mista	250 W	E27/E40	T3	368	458	1 ½"
	AIWNR/2-INC300P90	Incandescente	300 W	E27	T3	368	458	1 ½"

Roscas NPT

\* A pedido, as luminárias podem ser fornecidas com lâmpadas.

\*\* Para os tipos de fixação Plafonier "X", Arandela 30° "A30", a pedido, as entradas rosqueadas podem ser fornecidas no diâmetro de Ø1" NPT. Para os tipos de fixação Poste 25° "P25" e Poste 90° "P90", a pedido a entrada rosqueada pode ser fornecida no diâmetro de Ø2" NPT.

## DETALHES DA FIXAÇÃO

AIWNR /P Pendente

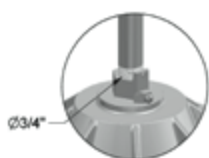

AIWNR /X Plafonier

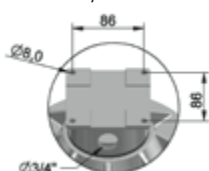

AIWNR /A30 Arandela 30°

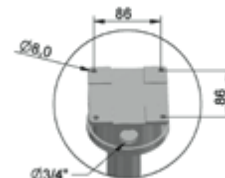

AIWNR /A90 Arandela 90°

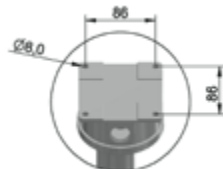

AIWNR /P25 Poste 25°

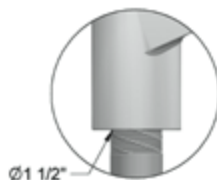

AIWNR /P90 Poste 90°

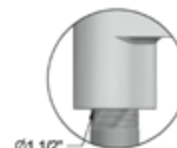

1

2

3

4

5

6

7

## DETALHES CONTRUTIVOS

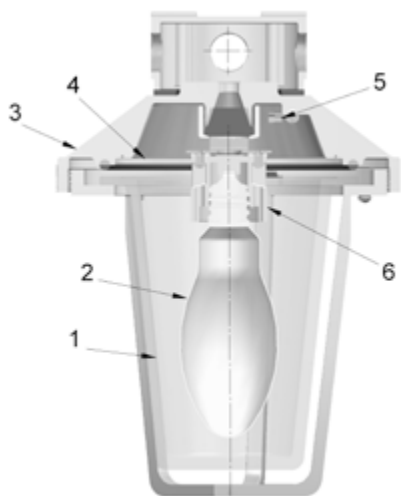

- 01- Conjunto ótico
- 02- Lâmpada
- 03- Corpo
- 04- Refletor
- 05- Terminal para aterramento
- 06- Conjunto soquete

### REFLETOR ESMALTADO

Fabricado em chapa de aço esmaltado a fogo na cor branca internamente e na cor verde externamente. Os refletores são fornecidos separadamente. A pedido pode ser fornecido em chapa de alumínio.

**NORMAL**



**CONCENTRADOR**

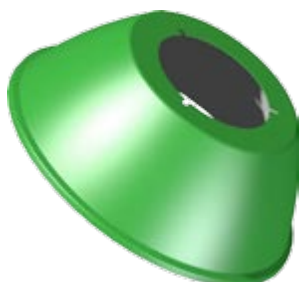

**ANGULAR**



Produto	Código	Luminária Modelo	Dimensões (mm)	
			A	ØB
	RNW-1	AIWNR/1	140	405
	RNW-2	AIWNR/2	170	530
	RCW-1	AIWNR/1	200	405
	RCW-2	AIWNR/2	245	530
	RAW-1	AIWNR/1	405	530
	RAW-2	AIWNR/2	285	320